

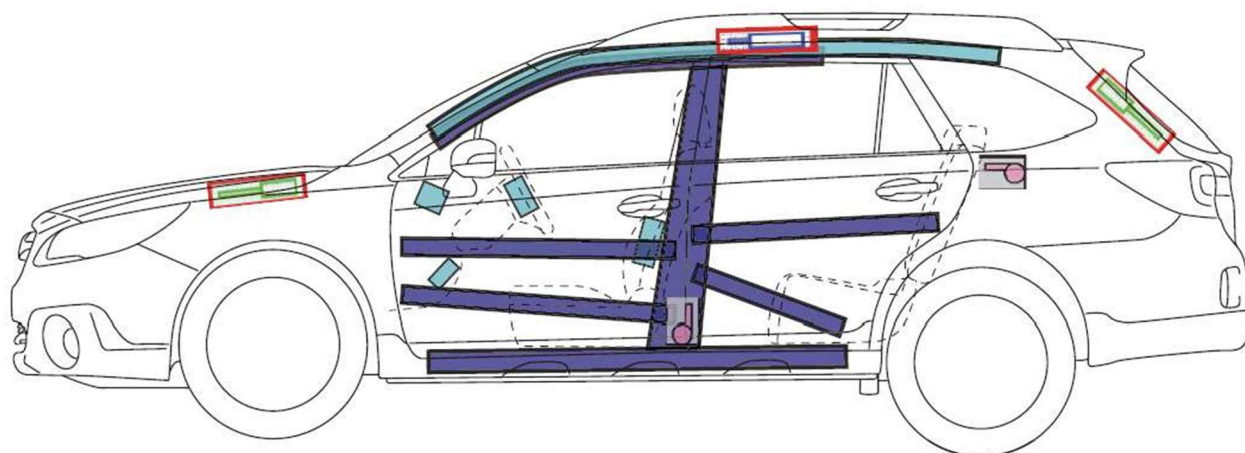

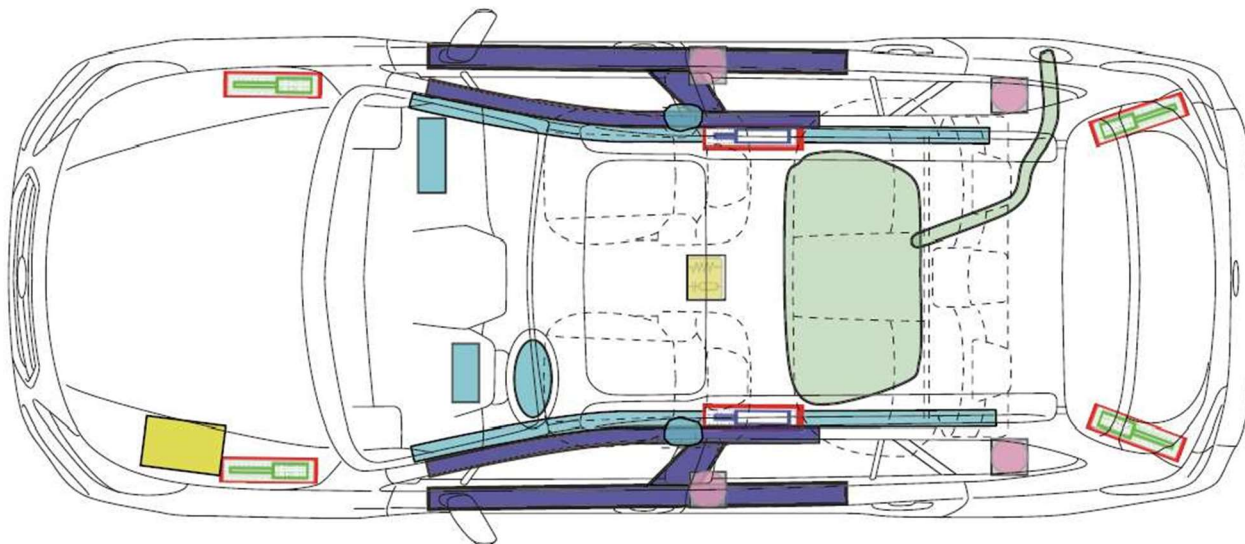





SUBARU: Typ Outback 2.5L i
 2.0D: BSD/BS9
 Wariant nadwozia od roku 2015



Moduł poduszki powietrznej		Wzmocnienie nadwozia		Moduł sterujący poduszki powietrznej	
Generator gazu poduszki powietrznej szyby				Akumulator	
Napinacze pasów		Amortyzatory klapy bagażnika		Zbiornik paliwa	

Ostrzeżenie

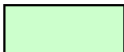
Po odłączeniu akumulatora odczekaj 30 sekund.